

Table of Contents

1. Warnings	3
1.1. 120 VAC operation	3
1.2. Shock Hazard	3
2. Unpacking, Installation, and Connection of the Timer/Controller	3
2.1. What's in the box?	3
2.2. Mount the timer/controller	4
2.3. Data I/O connections (if applicable)	4
2.4. Power connection.	4
3. Understanding the control panel	4
3.1. On-Off Switch and circuit protection	4
3.2. MENU button	4
3.3. SCROLL button	4
3.4. Left & Right Arrows	4
3.5. 3-Digit LED Display	4
3.6. Individual LEDs.	5
4. Timer/Controller Self-Test	5
5. Priming the pump	5
6. Programming for desired pump output	6
6.1. How it works	6
6.2. Set the "ON" time	6
6.3. Set the "OFF" time	6
7. Accessing Temperature Controlled Operation	7
7.1. Turn the Temperature Mode on/off	7
7.2. Set the desired temperature	7
7.3. Temperature sensor calibration	8
8. MODBUS Information	9
8.1. Channel Selection	9
8.2. Communication Details (MODBUS)	9
8.3. Data Port Pinout	9
9. Pump Output Table	10
10. Calculating Approximate Outputs	11

1. Warnings

1.1. 120 VAC operation

1.1.1. Your Sidewinder AC Pump and Timer/Controller is designed to plug into a standard grounded 120 VAC outlet. It will not run on alternate voltages, and must only be connected to a grounded outlet. Use a certified electrician to insure proper supply and connection of 120 VAC for the unit.

1.2. Shock Hazard

1.2.1. There are no user serviceable parts in the Timer/Controller. As in any 120 VAC device, serious injury or death can occur with improper service/contact to internal parts. Hazardous voltage is present in the non-accessible, inside part of the timer/controller box, and the motor is powered by 120 VAC. Always disconnect the timer/controller before connecting or disconnecting the motor from the timer/controller. The timer/controller should ONLY be serviced by trained Sidewinder personnel.



2. Unpacking, Installation, and Connection of the Timer/Controller

2.1. What's in the box?

2.1.1. Your Sidewinder AC Timer/Controller is packed with your Sidewinder AC Pump unit. The box contains the following items

- (1) AC Pump (Simplex or Duplex)
- (1) Timer/Controller unit with integral mounting bracket for fastening to the AC Pump
- (1) Circular connector (solder type connections) for use with the data port on the timer/controller. (Note: Sidewinder does not provide data cable.)



2.2. Mount the timer/controller (Your Sidewinder AC Pump should be mounted to a Sidewinder stand or to your structure prior to this step.)

2.2.1. Fasten the timer/controller bracket to the top of the AC Pump using the (2) Hex Head 1/4-20 Stainless Steel Screws shipped installed on the pump head.

2.2.2. Connect the Pump to the Timer/Controller. The AC Pump is pre-wired with a circular connector that mates with the timer/controller. Push it in place and twist till securely fastened.

2.3. Data I/O connections (if applicable)

2.3.1. Solder your data line to the supplied circular connector.

The pin-out is as follows:

2.3.1.1. PIN 1 is the (+) Signal

2.3.1.2. PIN 2 is the (-) Signal

2.3.1.3. PIN 3 is ground

2.3.2. Connect the circular connection to the data port located on the rear of the timer/controller.

2.4. Power connection. Power is delivered to the AC Pump via a standard AC power cord. Sidewinder suggests leaving the unit unplugged until the pump is plumbed and ready to prime. However, the timer/controller does have an on/off circuit breaker switch which not only provides a means of power switching, but also provides a resettable over-current protection.

2.4.1. NOTE: ALL WIRING MUST BE DONE BY A CERTIFIED ELECTRICIAN. THERE ARE NO USER SERVICEABLE PARTS.

3. Understanding the control panel

3.1. On-Off Switch and circuit protection

3.1.1. This switch functions as both an on-off switch and also provides a resettable circuit breaker function.



3.2. MENU button – stops pump function immediately, and enables programming and setting access.

(NOTE: if no button is pressed, the pump will resume normal operation after 1 minute.)



3.3. SCROLL button – used to toggle between various setting areas.

3.4. Left & Right Arrows – used to change settings.

3.5. 3-Digit LED Display

3.5.1. This display shows setting values, and during operation counts down as the pump cycles on and off.

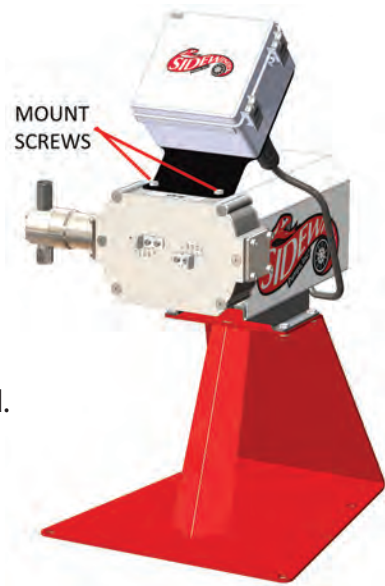

3.6. Individual LEDs.

3.6.1. There are (7) individual LEDs.

3.6.1.1. PUMP ON – Lights any time the pump is running. Flashes when the controller is in “SECONDS ON” or “MINUTES ON” setting mode.



3.6.1.2. PUMP OFF – Lights when the pump is in a non-running portion of the cycle. Flashes when the controller is in “SECONDS OFF” or “MINUTES OFF” setting mode.

3.6.1.3. PRIME – Lights when the prime function is being used. (Described in section 4 below.)

3.6.1.4. SET SECONDS - Flashes when the controller is in the “SET SECONDS” mode. Lights when in run mode and seconds are counting down.

3.6.1.5. SET MINUTES – Flashes when the controller is in the “SET MINUTES” mode. Lights when in run mode and minutes are counting down.

3.6.1.6. TEMPERATURE – Lights when the temperature mode is “ON” and temperatures are at or below the set point. Flashes when the temperature mode is “ON” but temperatures are above the set point.

3.6.1.7. MODBUS – Lights when accessing MODBUS address function.

4. Timer/Controller Self-Test

When the timer/controller is first turned on, a small “self-test” is performed. Each digit on the three digit LED display will countdown to 0. During this countdown, the “PUMP OFF” LED will be illuminated. After the self-test is complete, the “POWER ON” LED will illuminate and the pump will run at the last pump cycle settings. Pressing “MENU” at any time will stop pump operation for 1 minute.

5. Priming the pump

After your AC Pump is plumbed and ready to run, use the prime function to provide a continuous run of the pump motor for priming. PRIME can be accessed only while the controller is in the run mode.

5.1. Press the right arrow button, and the pump will ignore the cycle settings and run continuously for one minute. (The PRIME LED will turn on.)

Note: The prime function will not cause the pump to run if the temp mode is “ON”, and the actual temperature is not low enough to turn the pump on. Turn temp mode off to prime.

5.1.2. Press the right arrow again to stop the prime function at any time while the pump is running in the Prime mode. The pump reverts to a normal run mode.

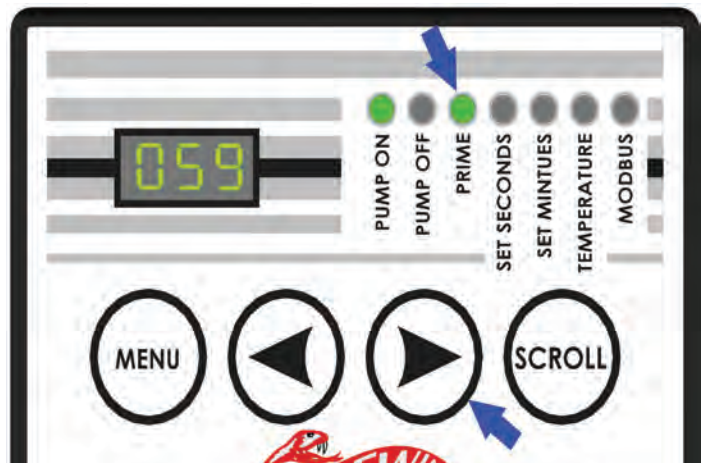

6. Programming for desired pump output

6.1. How it works

6.1.1. Your Sidewinder AC Timer/Controller controls the AC Pump by setting two variables, Cycle “ON” time, and Cycle “OFF” time. Charts are provided that provide estimated outputs based on your setting selections. Output can be set up for intermittent dosing, or for batch type dosing. The chart on page 10 of this document provides an estimated setting, but Sidewinder strongly recommends that output be verified using a pump calibration gauge. NOTE: Flow rates less than 1.2 Qts/Day may be achieved by setting “ON TIME” to seconds, and “OFF TIME” to minutes. Contact the factory for more information.

6.2. Set the “ON” time

6.2.1. To set the “ON” time, press “MENU”. The “PUMP ON” LED will flash, and the “SET SECONDS” LED will flash. The 3-digit LED will display the current setting. Use the left or right arrows to change the setting for number of seconds “ON”. This setting is adjustable from 0 – 59 seconds. Press the “SCROLL” button and the “SET SECONDS” LED quits flashing and the “SET MINUTES” LED will flash. This setting is adjustable from 0 to 60 minutes of on-time.

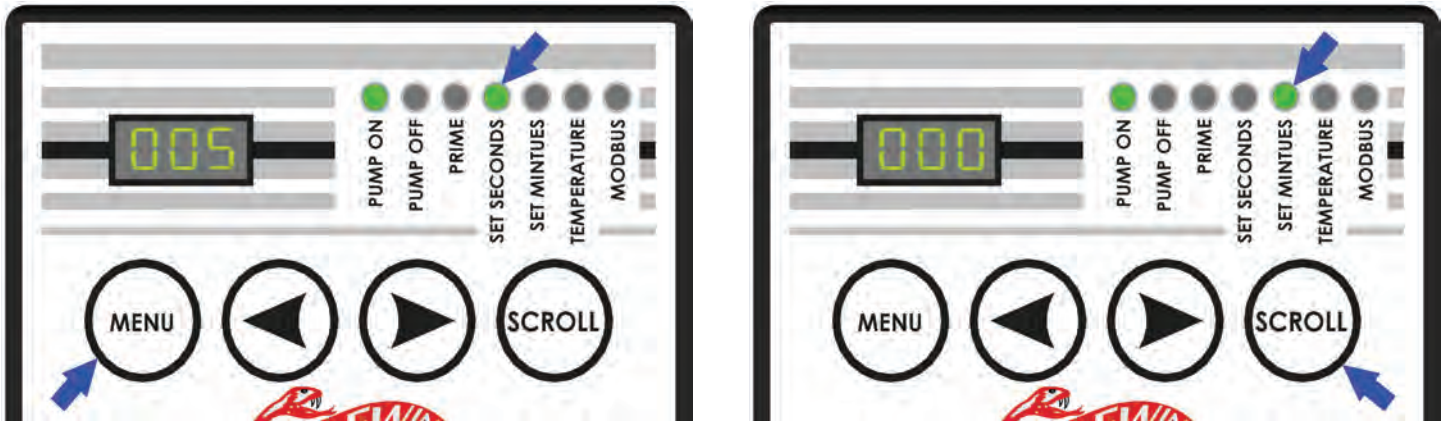

6.3. Set the “OFF” time

6.3.1. To set the “OFF” time, press “SCROLL” again. The “PUMP OFF” LED will flash, and the “SET SECONDS” LED will flash. The 3-digit LED will display the current setting. Use the left or right arrows to change the setting for number of seconds “OFF”. This setting is adjustable from 0 – 59 seconds. Press the “SCROLL” button and the “SET SECONDS” LED quits flashing and the “SET MINUTES” LED will flash. This setting is adjustable from 0 to 60 minutes of off-time. NOTE: Press “SCROLL” once more to lock the settings in, then press “MENU” to begin pump operation.

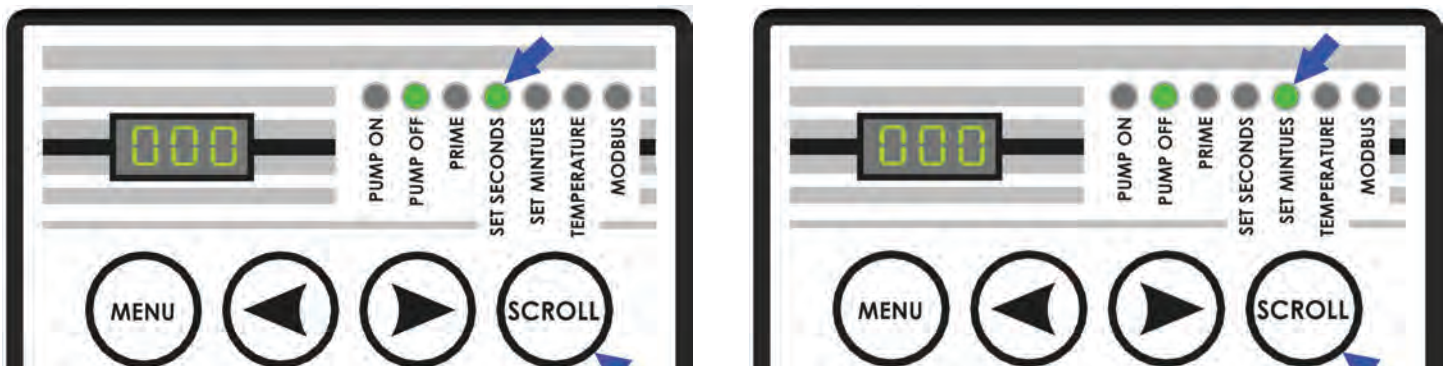

7. Accessing Temperature Controlled Operation

Your Sidewinder AC Pump Timer/Controller can also be set to run only after the ambient temperature near your pump has reached a temperature selected by you. After ambient temperature rises past the set point, the pump will shut off and remain off until the temperature is again, at or below the set point. The "TEMPERATURE" led will flash anytime the temperature mode is "ON" and ambient temperatures are not at or below the set point. It will be on, but stop flashing, when the ambient temperature is at or below your set point. The pump will run per your on-time, off-time settings.

7.1. Turn the Temperature Mode on/off

7.1.1. Press "SCROLL" until the "TEMPERATURE" LED flashes. The three digit LED display will say "ON" or "OFF" depending on the status of the temperature mode. If it is "OFF", pressing either of the arrow button changes the setting to "ON".

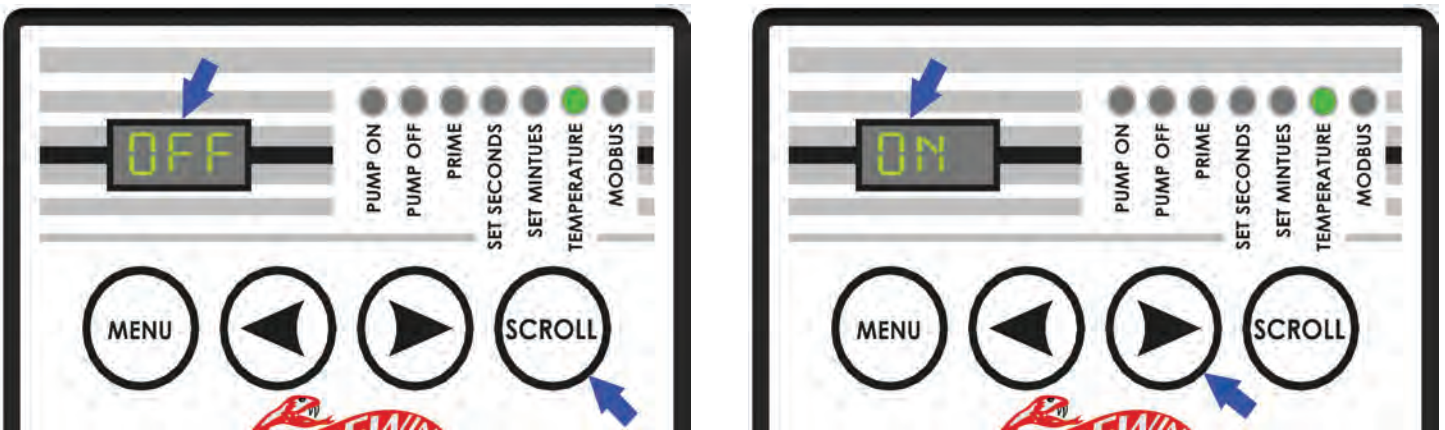

7.2. Set the desired temperature

7.2.1. When "ON" is displayed, pressing the "SCROLL" button enables setting of the temperature that you want the pump to start running. Press the arrow keys to change the temperature setting. Pressing "SCROLL" again exits the temperature setting mode. Press "MENU" to return to a run mode. Now, the pump will not run until the temperature drops to the set point. At that point, the pump will run, and will continue to run until the temperature rises above the set point, and the pump returns to a non-running mode.

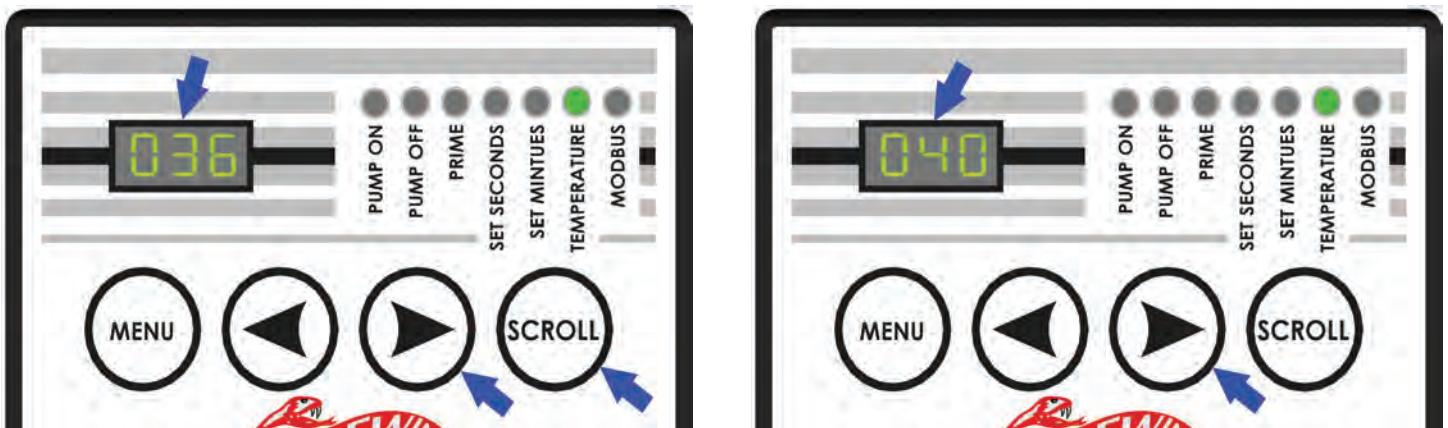

7.3. Temperature sensor calibration

(NOTE: Temperature mode should be in the "ON" setting prior to 7.3.1)

7.3.1. Turn the timer/controller off.

7.3.2. Hold both the "SCROLL" and "MENU" buttons down, and turn the unit "ON".



7.3.3. All LEDs and display segments will flash.

7.3.4. Release "SCROLL" and "MENU".

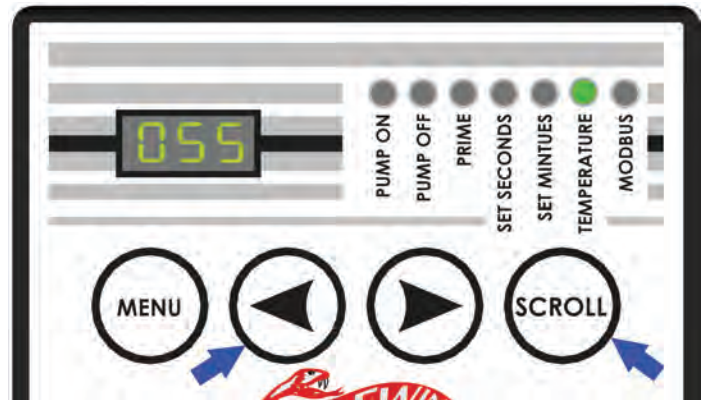
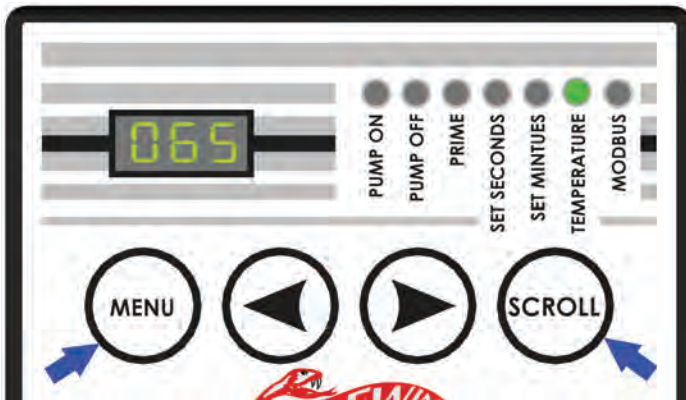

7.3.5. The unit will perform a self-test, and when complete, it will be in temperature calibration mode. The 3-digit LED display will show its measured temperature. If "OFF" is displayed, the unit was not in temp mode. Press either arrow key to enter temp mode. The temperature should now be displayed. Go to step 7.3.6.

7.3.6. Use the left and right arrows to decrease or increase the calibration by +/- 50 degrees Fahrenheit until the display shows the actual ambient temperature at that time. The display will show the internal temperature of the controller which can be impacted by the electronics, but should stabilize after the unit runs a while. For example, if the actual temperature at the site is 50 degrees, but your unit reads 65 degrees, press the left arrow until the display shows 55. Press "SCROLL" to lock in the calibrated setting. The pump will enter a normal run mode. If you do not press "SCROLL", your changes will not be saved.

NOTE: It is important to turn the timer on and allow its internal temperatures to stabilize before using this calibration mode. Wait at least 10 minutes of run time before calibrating the temperature shown on the display.

8. MODBUS Information

8.1. Channel Selection

8.1.1. Press "SCROLL" until the "MODBUS" LED flashes. The 3-digit LED display shows the current MODBUS channel selected. Use the arrows to change the setting. The default value is "16". The other MODBUS settings are:

Baud Rate = 9600
Data Bits = 8
Stop Bits = 1
Parity = none

8.2. Communication Details (MODBUS):

8.2.1. Discrete Input Contacts {Read Function 0x02}

Register 1: Low Battery Flag... 1=Voltage is less than 11.0V
Register 2: Battery Blink Flag... 1=Voltage is less than 10.0V
Register 3: High Temp Flag... 1=Temperature is greater than set point
Register 4: Update Flag... 1=Controller is updating the display

8.2.2. Analog Input Registers {Read Function 0x04}

Register 1: Current Temperature Reading
Register 2: Current Voltage Reading (decimal is assumed) i.e. 121 = 12.1V
Register 3: Current Run Timer – in seconds
Register 4: Current Off Time – in seconds
Register 5: Timeout – amount of time that the controller may be left in "MENU" mode.

8.2.3. Discrete Output Coils {Read Function 0x01}

Register 1: Output (pump) 1=on
Register 2: Temperature Mode 1=on
Register 3: Prime Mode 1=on
Write Single Coil: 0x05
Write Multiple Coils: 0x15

8.2.4. Analog Output Holding Registers {Read Function 0x03}

Register 1: On Timer: Seconds (0 to 59)
Register 2: On Timer: Minutes (0 to 15)
Register 3: Off Timer: Seconds (0 to 59)
Register 4: Off Timer: Minutes (0 to 15)
Temperature Set Point (-40 to 100) Degrees F
Modbus Address (1 to 127)
Elapsed Timer (not saved – starts at 0 on power up)
Write Single Holding Register: 0x06
Write Multiple Holding Registers: 0x16

8.3. Data Port Pinout

PIN 1: (+) SIGNAL; PIN 2: (-) SIGNAL; PIN 3: GROUND

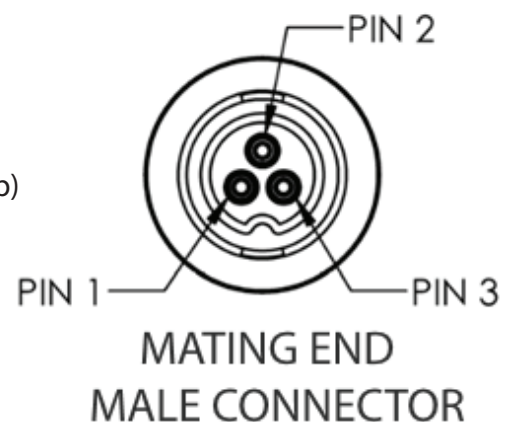

APPROXIMATE QUARTS PER DAY AT VARIOUS ON-TIME / OFF-TIME SETTINGS

(ALWAYS VERIFY ACTUAL OUTPUT WITH A PUMP CALIBRATION GAUGE)

BATCH DOSING SETTINGS														
PLUNGER DIAMETER	ON MIN	OFF MIN	SIMPLEX QTS / DAY	DUPLEX QTS / DAY	PLUNGER DIAMETER	ON MIN	OFF MIN	SIMPLEX QTS / DAY	DUPLEX QTS / DAY	PLUNGER DIAMETER	ON MIN	OFF MIN	SIMPLEX QTS / DAY	DUPLEX QTS / DAY
1/4"	60	0	73.5	146.9	3/8"	60	0	165.3	330.6	1/2"	60	0	293.9	587.8
1/4"	55	5	67.3	134.7	3/8"	55	5	151.5	303.1	1/2"	55	5	269.4	538.8
1/4"	50	10	61.2	122.4	3/8"	50	10	137.8	275.5	1/2"	50	10	244.9	489.8
1/4"	45	15	55.1	110.2	3/8"	45	15	124.0	248.0	1/2"	45	15	220.4	440.8
1/4"	40	20	49.0	98.0	3/8"	40	20	110.2	220.4	1/2"	40	20	195.9	391.8
1/4"	35	25	42.9	85.7	3/8"	35	25	96.4	192.9	1/2"	35	25	171.4	342.9
1/4"	30	30	36.7	73.5	3/8"	30	30	82.7	165.3	1/2"	30	30	146.9	293.9
1/4"	25	35	30.6	61.2	3/8"	25	35	68.9	137.8	1/2"	25	35	122.4	244.9
1/4"	20	40	24.5	49.0	3/8"	20	40	55.1	110.2	1/2"	20	40	98.0	195.9
1/4"	15	45	18.4	36.7	3/8"	15	45	41.3	82.7	1/2"	15	45	73.5	146.9
1/4"	10	50	12.2	24.5	3/8"	10	50	27.6	55.1	1/2"	10	50	49.0	98.0
1/4"	5	55	6.1	12.2	3/8"	5	55	13.8	27.6	1/2"	5	55	24.5	49.0
1/4"	1	59	1.2	2.4	3/8"	1	59	2.8	5.5	1/2"	1	59	4.9	9.8
INTERMITTENT FLOW SETTINGS														
PLUNGER DIAMETER	ON SEC	OFF SEC	SIMPLEX QTS / DAY	DUPLEX QTS / DAY	PLUNGER DIAMETER	ON SEC	OFF SEC	SIMPLEX QTS / DAY	DUPLEX QTS / DAY	PLUNGER DIAMETER	ON SEC	OFF SEC	SIMPLEX QTS / DAY	DUPLEX QTS / DAY
1/4"	60	0	73.5	146.9	3/8"	60	0	165.3	330.6	1/2"	60	0	293.9	587.8
1/4"	55	5	67.3	134.7	3/8"	55	5	151.5	303.1	1/2"	55	5	269.4	538.8
1/4"	15	3	61.2	122.4	3/8"	15	3	137.8	275.5	1/2"	15	3	244.9	489.8
1/4"	12	4	55.1	110.2	3/8"	12	4	124.0	248.0	1/2"	12	4	220.4	440.8
1/4"	6	3	49.0	98.0	3/8"	6	3	110.2	220.4	1/2"	6	3	195.9	391.8
1/4"	7	5	42.9	85.7	3/8"	7	5	96.4	192.9	1/2"	7	5	171.4	342.9
1/4"	8	8	36.7	73.5	3/8"	8	8	82.7	165.3	1/2"	8	8	146.9	293.9
1/4"	7	10	30.3	60.5	3/8"	7	10	68.1	136.1	1/2"	7	10	121.0	242.0
1/4"	6	12	24.5	49.0	3/8"	6	12	55.1	110.2	1/2"	6	12	98.0	195.9
1/4"	4	12	18.4	36.7	3/8"	4	12	41.3	82.7	1/2"	4	12	73.5	146.9
1/4"	2	10	12.2	24.5	3/8"	2	10	27.6	55.1	1/2"	2	10	49.0	98.0
1/4"	2	22	6.1	12.2	3/8"	2	22	13.8	27.6	1/2"	2	22	24.5	49.0
1/4"	1	59	1.2	2.4	3/8"	1	59	2.8	5.5	1/2"	1	59	4.9	9.8

MAXIMUM PRESSURES: 1/4" - 5000 PSI, 3/8" - 2500 PSI, 1/2" 1250 PSI

9. Pump Output Table - (NOTE: Output rates less than 1.2 Qts/day can be achieved by setting "ON TIME" to seconds and "OFF TIME" to minutes. Contact the factory for more information.)

10. Calculating Approximate Outputs

V1 = Quarts per stroke

1/4" plungers ... V1 = 0.000850339

3/8" plungers ... V1 = 0.001913263

1/2" plungers ... V1 = 0.003401357

T1 = On time

T2 = Off time

C1 = Cycles /Day (if seconds)

C1 = 86,400 / (T1 + T2) i.e. If T1 = 5 sec and T2 = 5 sec
C1 = 86,400 / (5 + 5) = 8,640 Cycles/Day

C1 = Cycles /Day (if minutes)

C1 = 1440 / (T1 + T2) i.e. If T1 = 10 min and T2 = 10 min
C1 = 1440 / (10 + 10) = 72 Cycles/Day

(Note: These calculations assume 1 full stroke per second of motor run. At lower pressures more than one stroke per second may be achieved.)

Q1 = QUARTS PER DAY = V1 x C1 x T1

In Example:

For a Simplex Pump with a 1/4" plunger, T1 = 10 sec, T2 = 5 sec

C1 = 86,400 / (10 + 5) = 5760 cycles/day

Q1 = 0.000850339 quarts/stroke x 5760 x 10 = 48.98 Quarts/Day

For a Simplex Pump with a 1/2" plunger, T1 = 10 min, T2 = 20 min

C1 = 1440 / (10 + 20) = 48 cycles/day

Q1 = 0.003401357 x 48 x 10 = 1.63 Quarts/Day

For Duplex Pumps pumping to the same location, add the two pumps totals, or multiply by (2) if both sides of the pump have the same size plunger.

Please NOTE: These calculations provide an estimated output. Sidewinder strongly recommends that you use a pump setting gauge to insure accurate daily output.

CAUTION! This timer/controller operates on 120 VAC and must be installed by a certified electrician. Any service must be performed by trained personnel. There are no user serviceable parts in the timer or pump motor.



"Dedicated to providing state of the art metering solutions for all your chemical treatment needs."



There ain't no better pump

107 Commission Blvd., Lafayette, Louisiana 70508
P.O. Box 80769, Lafayette, LA 70598-0769
(337) 235-9838 / Fax (337) 235-9852 • www.sidewinderpumps.com